

**HET CEO-PROJECT
EEN EERSTE POGING TOT
WWW BEHEER**

Aiko Pras

**CTIT WORKSHOP
19 APRIL 1996
BAD BOEKELO**

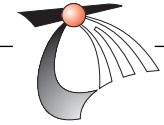

BACKGROUND

JOINT RESEARCH CENTRE (JRC)

- EUROPEAN COMMISSION
- ISPRA - ITALY

CENTRE FOR EARTH OBSERVATION (CEO)

PROVIDERS OF
EARTH OBSERVATION DATA



USERS OF
EARTH OBSERVATION DATA

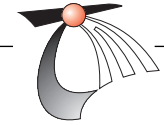

BACKGROUND

PROVIDERS

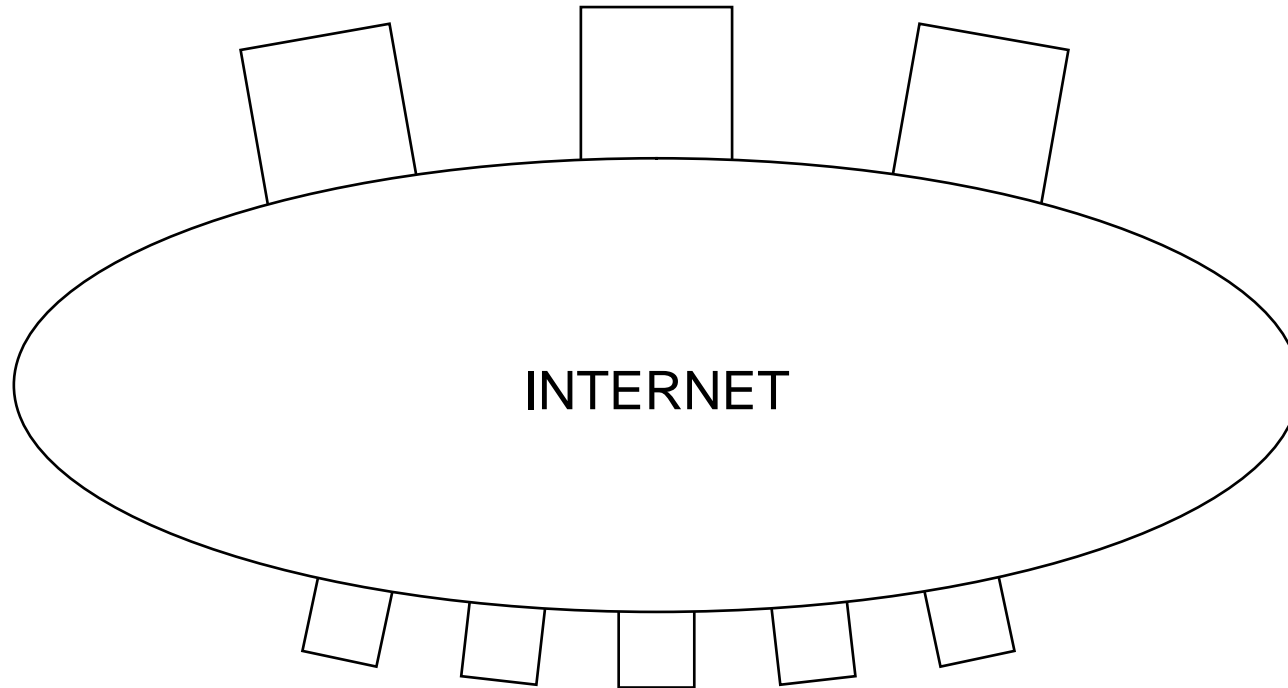

USERS

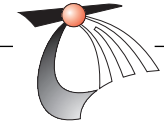

BACKGROUND

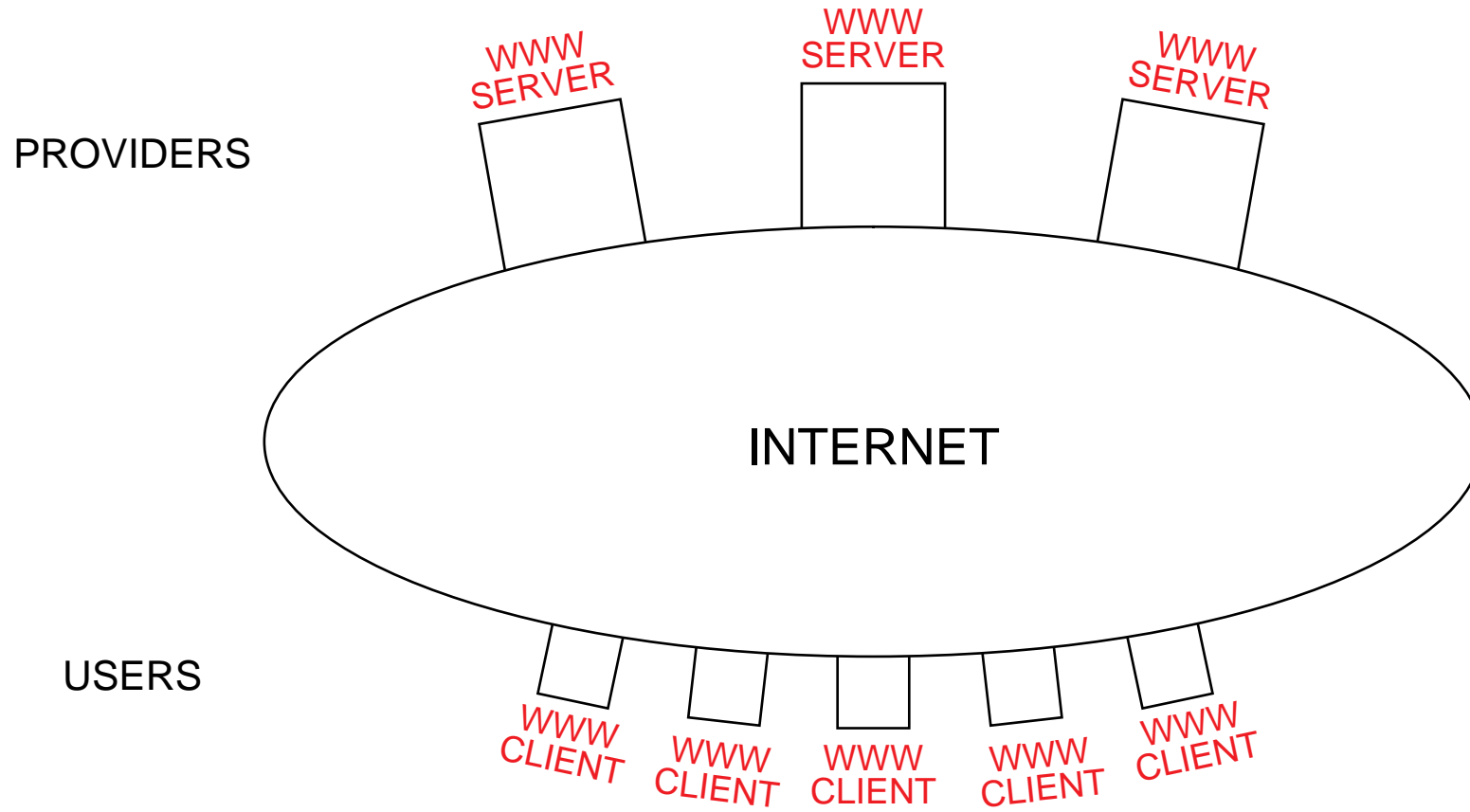

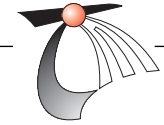

BACKGROUND

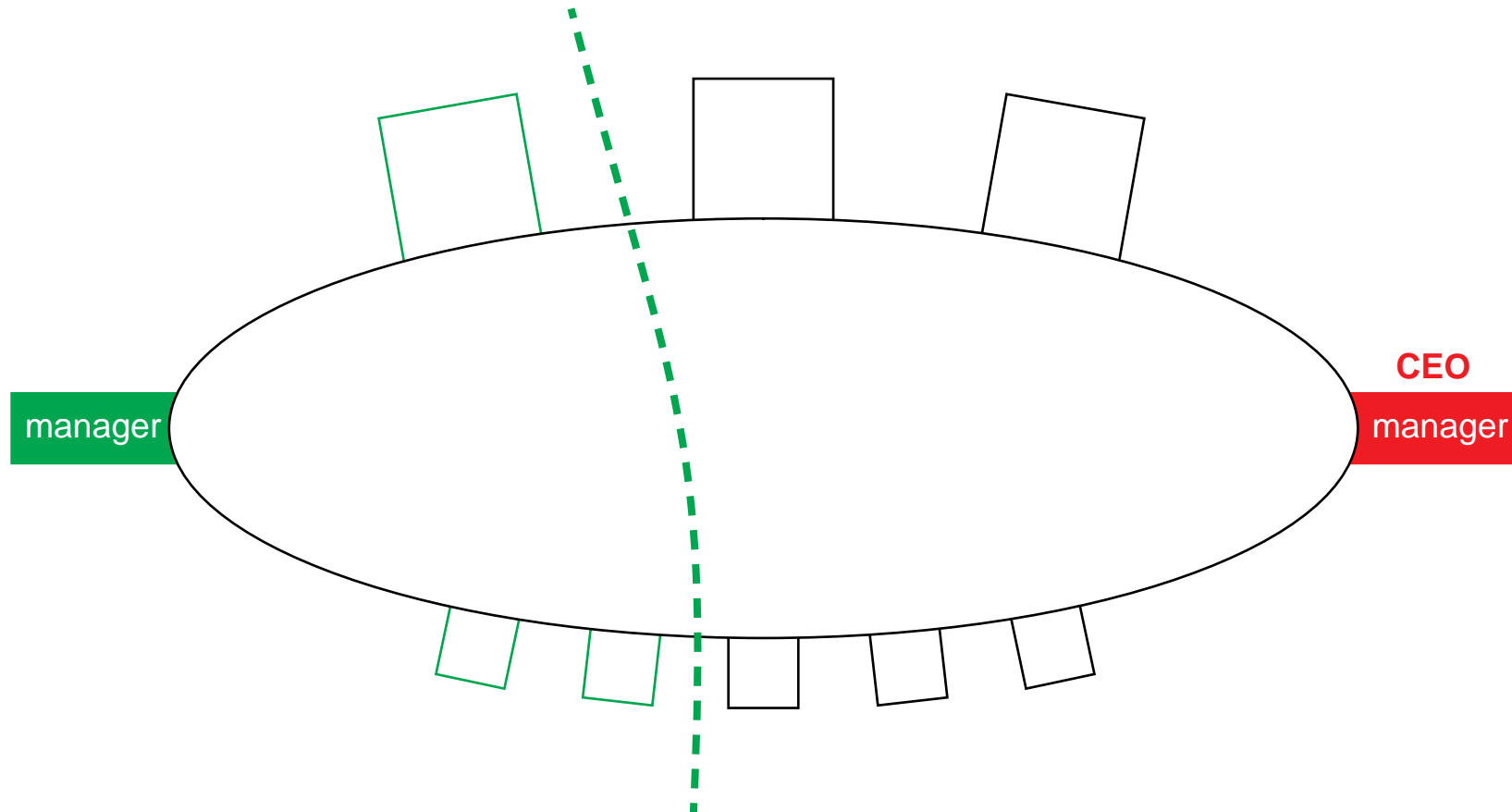

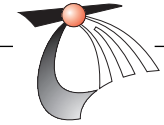

BACKGROUND

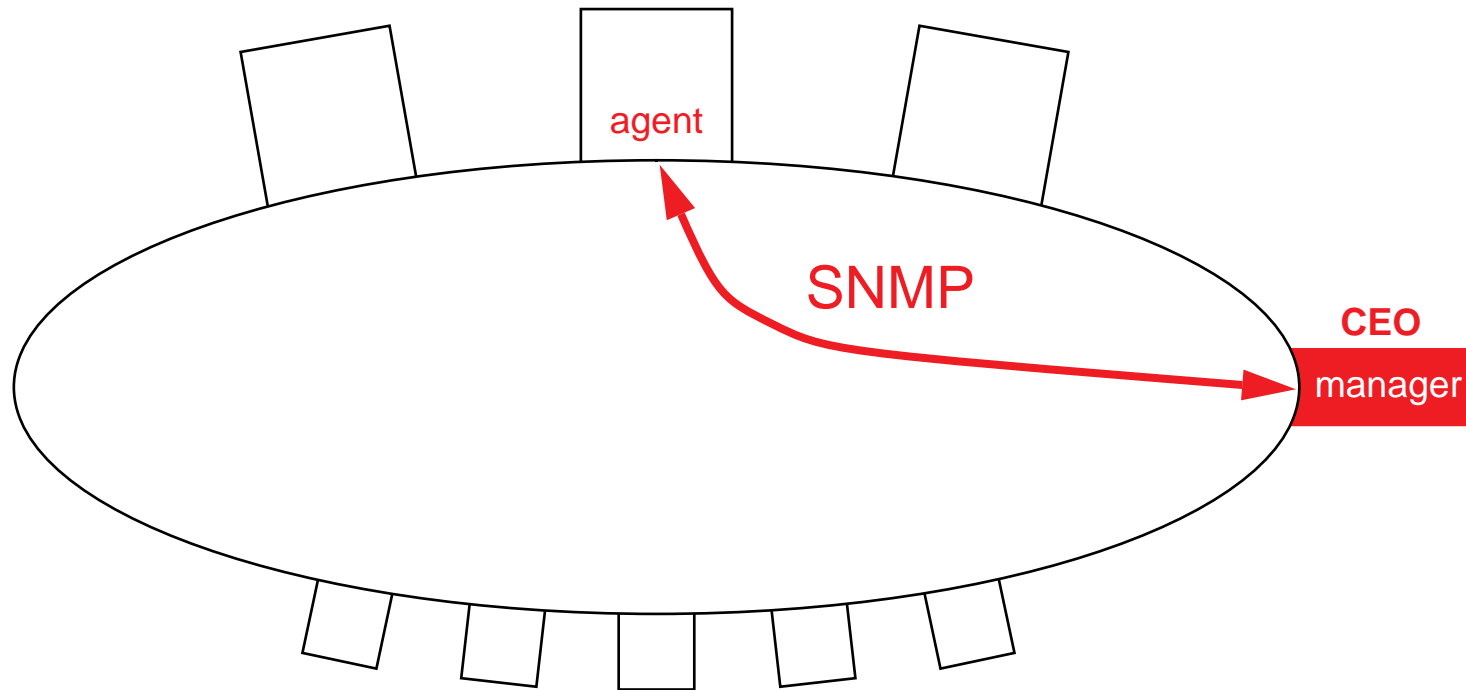

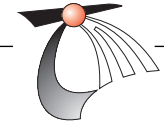

PROOF OF CONCEPT

WWW MANAGEMENT:

- DESIGN AND DEMONSTRATION
 - FIRST PROJECT OF A SERIE

PARTNERS:

- ESYS LTD. - GUILDFORD, UK
 - CTIT - UT, NL
- 9 MONTHS - 120.000 ECU

WORK DIVISION:

- ARCHITECTURE: ESYS & CTIT
 - MANAGER: ESYS
 - AGENT: CTIT

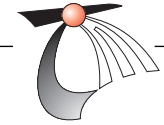

ARCHITECTURE

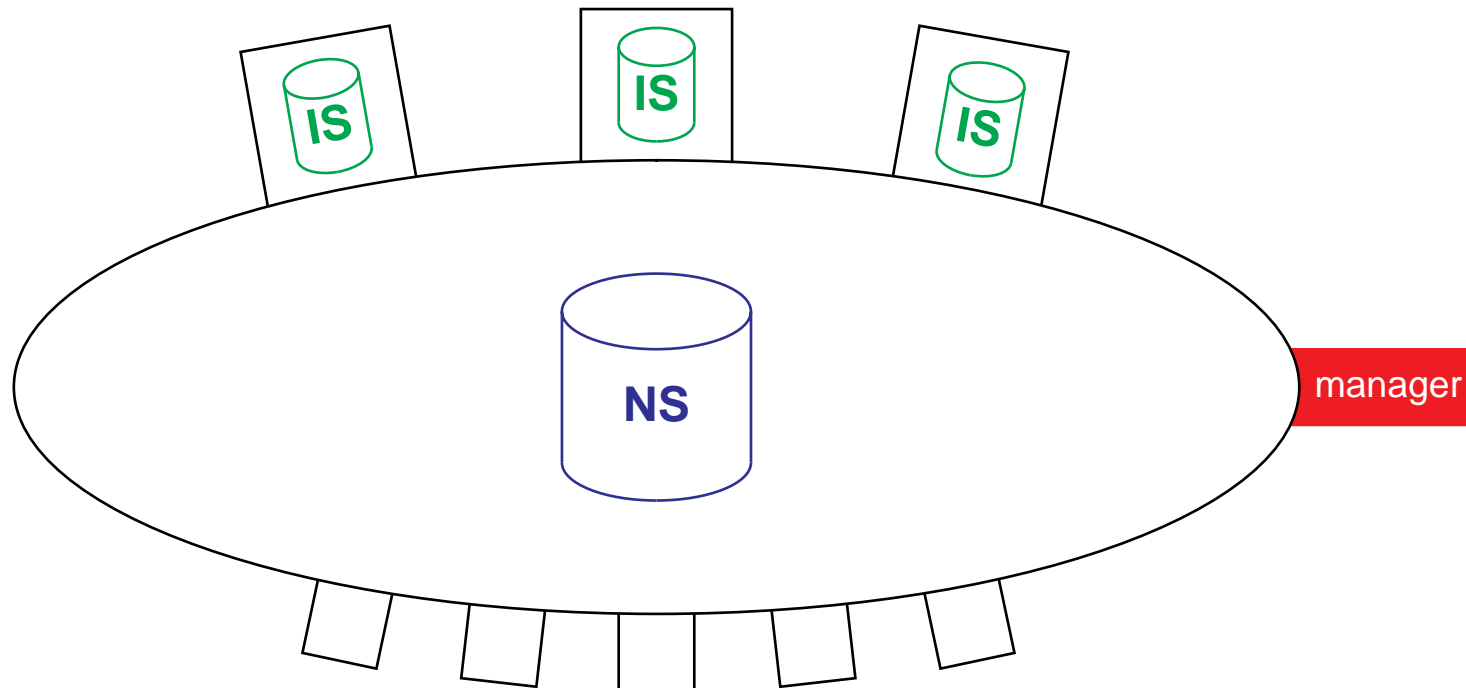

IS = INFORMATION STORE MIB
NS = NETWORK SERVICE MIB
MIB = MANAGEMENT INFORMATION BASE

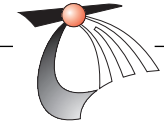

MIBS

IS-MIB:

- GENERAL INFORMATION ABOUT THE SERVER
 - ACCESS INFORMATION
 - DOCUMENT INFORMATION
 - ERROR INFORMATION

NS-MIB:

- USER INFORMATION
- TRAFFIC PATTERNS
- QUALITY OF SERVICE (QoS)



IS-MIB

ACCESS INFORMATION

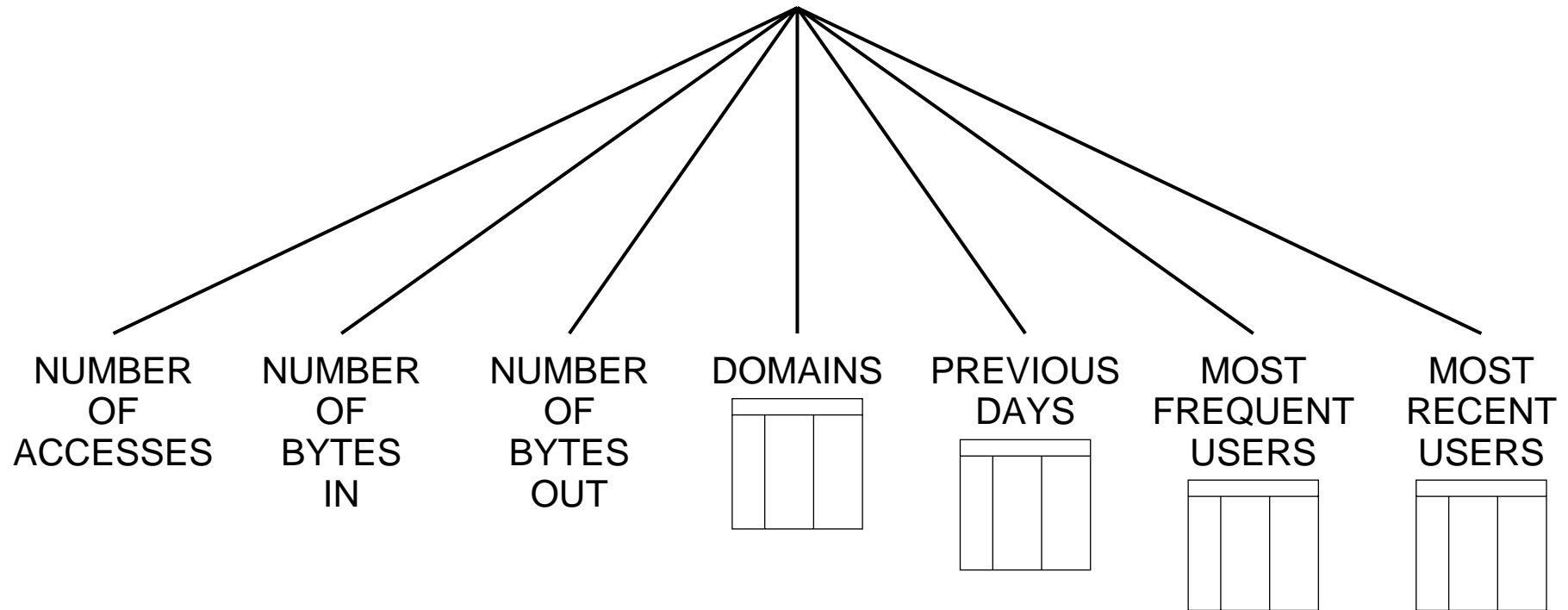

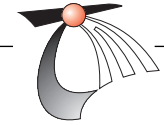

NS-MIB

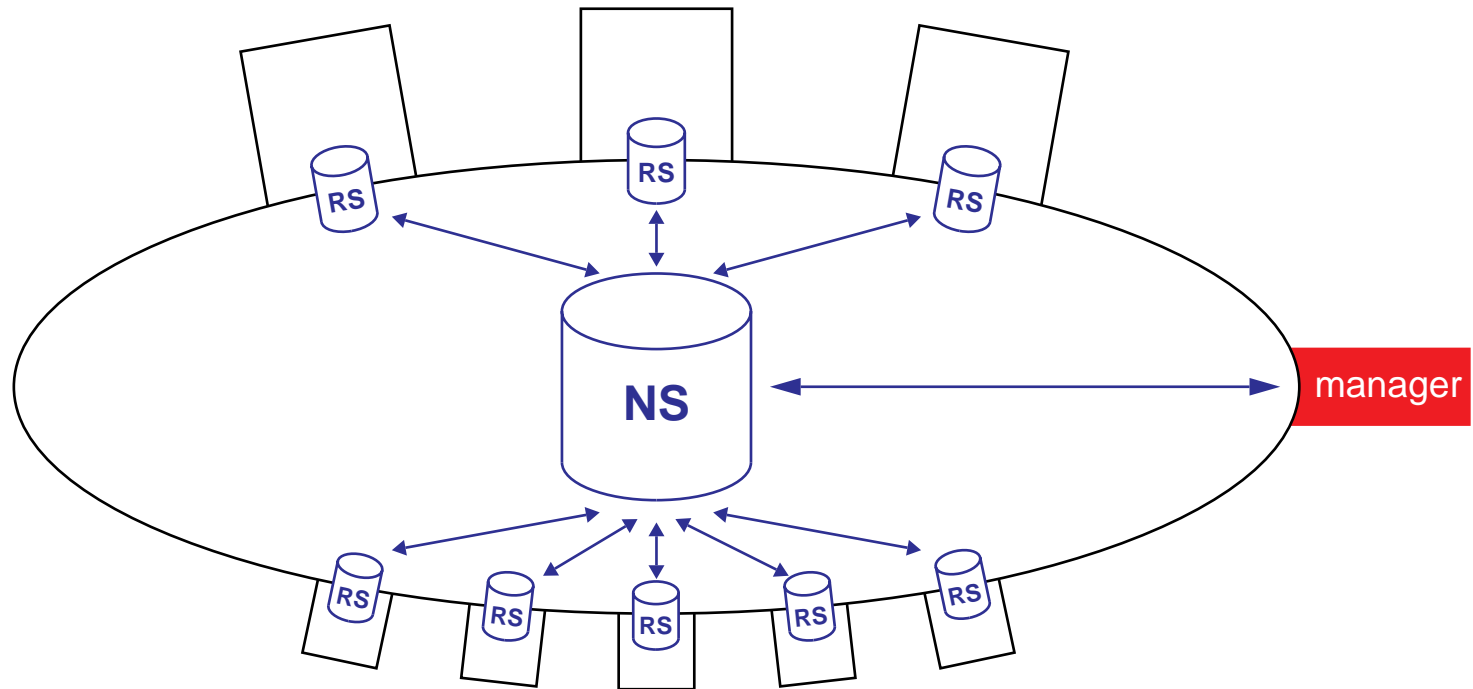

NS = NETWORK SERVICE MIB
RS = RETRIEVAL SERVICE MIB

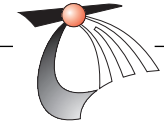

RS-MIB

TRAFFIC PATTERN:

- # REQUESTS
- # INDICATIONS
- # RESPONSES
- # CONFIRMS

QUALITY OF SERVICE:

- DELAY PER DESTINATION
- THROUGHPUT PER DESTINATION
 - # TIME-OUTS
 - # ERRORS

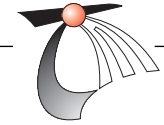

OTHER-MIBS

WWW-SERVER SYSTEM

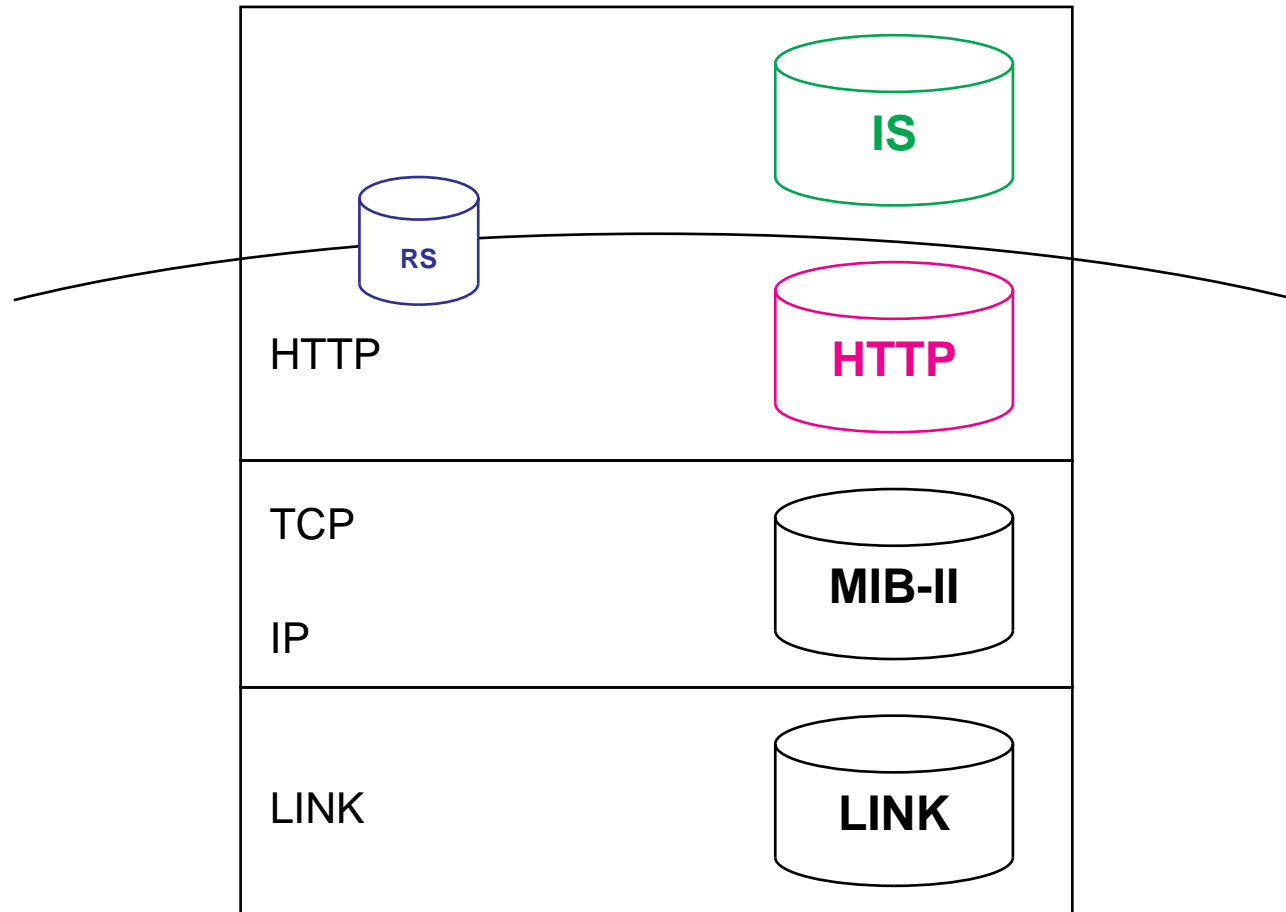

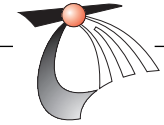

AGENT IMPLEMENTATION

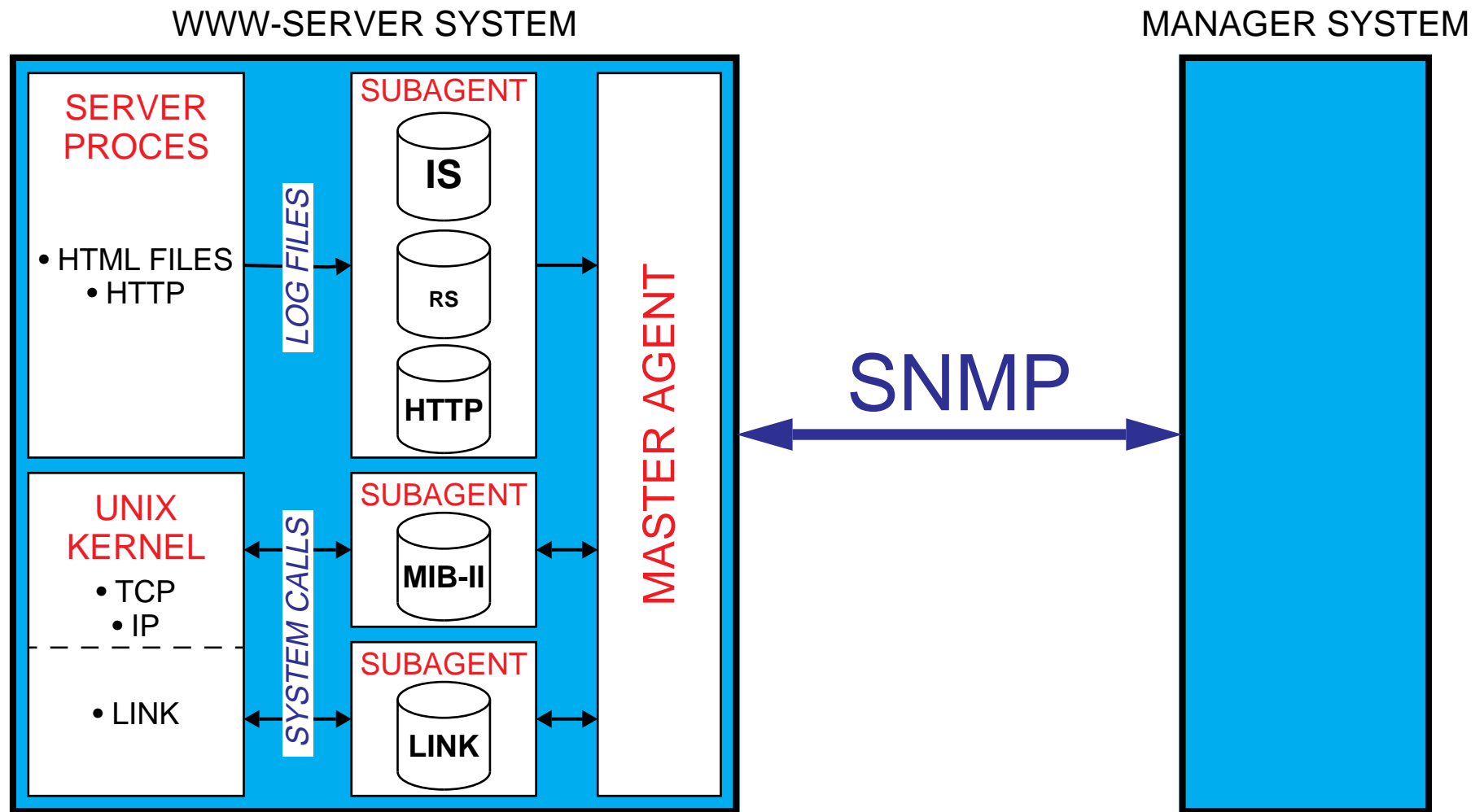

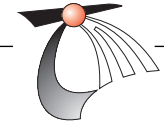

SUBAGENT IMPLEMENTATION

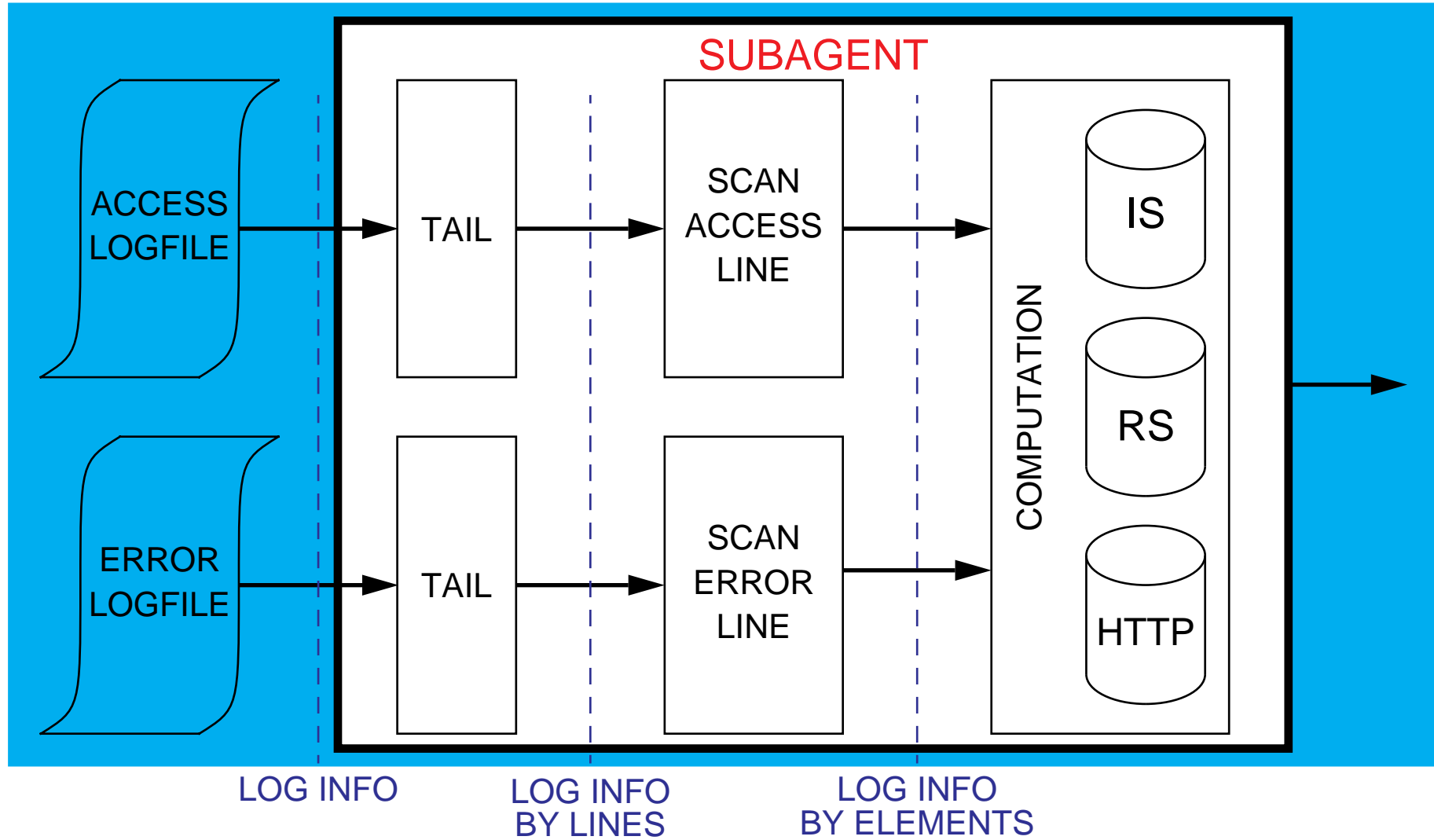

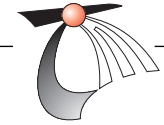

RESULTS

- AGENT HAS BEEN DEMONSTRATED SUCCESSFULLY
- FIRST WWW-MANAGEMENT SYSTEM IN THE WORLD
 - STANDARDIZATION WITHIN IETF
 - RELATION WITH APPLICATION MIB
 - FOLLOW-UP CONTRACT?
 - NWO - SION?